

SS.DSS

STAINLESS STEEL DOUBLE SWIVEL SHACKLE

METRIC THREADS

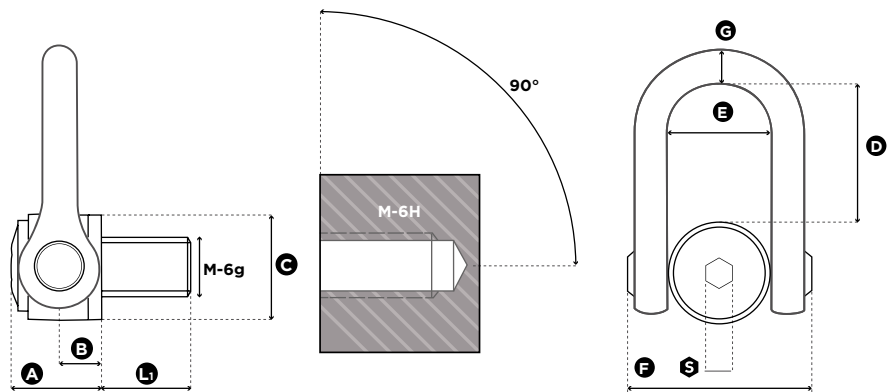

1 in = 25.4 mm

Reference	Diameter	SF 5:1 WLL (t)	SF 4:1 WLL (t)	Standard L1 (mm)	Torque (Nm)	S (mm)	A (mm)	B (mm)	C (mm)	D (mm)	E (mm)	F (mm)	G (mm)	Weight (kg)
SS.DSS M 24	M 24 (x3)	2,70	2,70*	36	160	19	61	31	70	98	73	149	30	5,2
SS.DSS M 30	M 30 (x3,5)	3,50	3,50*	45	250	19	61	31	70	98	73	149	30	5,2
SS.DSS M 33	M 33 (x3,5)	3,50	3,50*	50	250	19	61	31	70	98	73	149	30	5,2
SS.DSS M 36	M 36 (x4)	5,00	5,00*	54	320	19	61	31	70	98	73	149	30	5,2
SS.DSS M 36x3	M 36 (x3)	5,00	5,00*	54	320	19	61	31	70	98	73	149	30	5,2
SS.DSS M 39	M 39 (x4)	5,00	5,00*	54	320	19	61	31	70	98	73	149	30	5,4
SS.DSS M 42	M 42 (x4,5)	6,00	6,00*	63	400	19	61	31	70	98	73	149	30	5,4
SS.DSS M 42x3	M 42 (x3)	6,00	6,00*	63	400	19	61	31	70	98	73	149	30	5,4
SS.DSS M 45	M 45 (x4,5)	/ *	6,00	63	400	19	61	31	70	98	73	149	30	5,7
SS.DSS M 48	M 48 (x5)	/ *	6,40	68	600	19	79	38	90	123	91	182	41	11,0
SS.DSS M 48x3	M 48 (x3)	/ *	6,40	68	600	19	79	38	90	123	91	182	41	11,0
SS.DSS M 48x4	M 48 (x4)	/ *	6,40	68	600	19	79	38	90	123	91	182	41	11,0
SS.DSS M 52	M 52 (x5)	/ *	6,40	68	600	19	79	38	90	123	91	182	41	11,2
SS.DSS M 56	M 56 (x5,5)	/ *	8,00	78	600	19	79	38	90	123	91	182	41	11,3
SS.DSS M 56x4	M 56 (x4)	/ *	8,00	78	600	19	79	38	90	123	91	182	41	11,4

* In certification process / En cours d'homologation / In Entwicklungsphase / En proceso de homologación

12.2018